

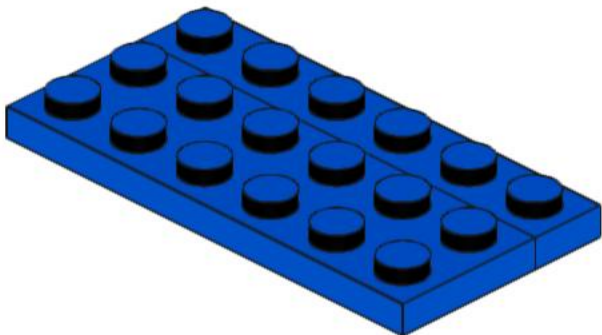

1

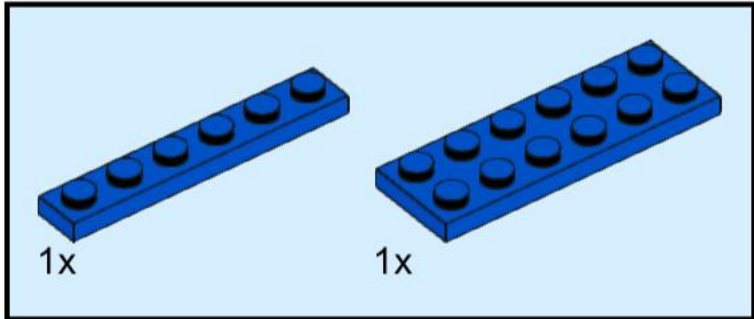

2

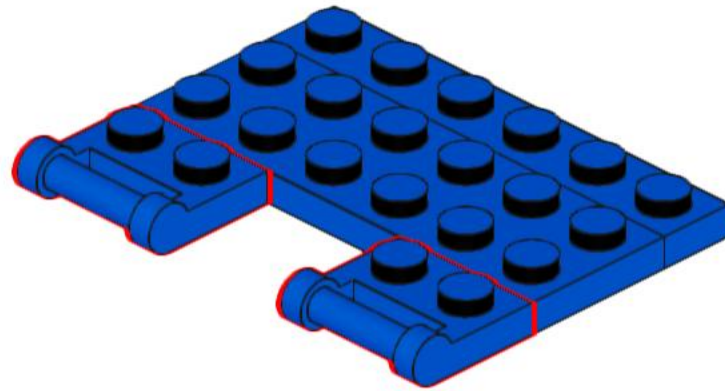
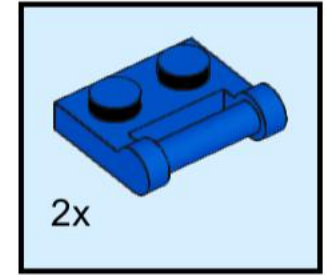

3

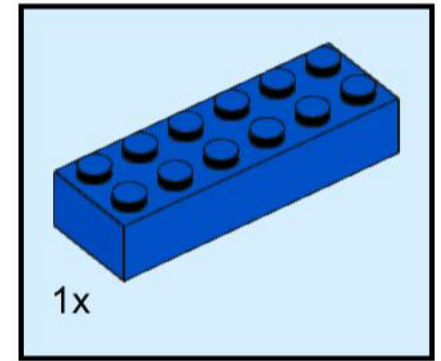
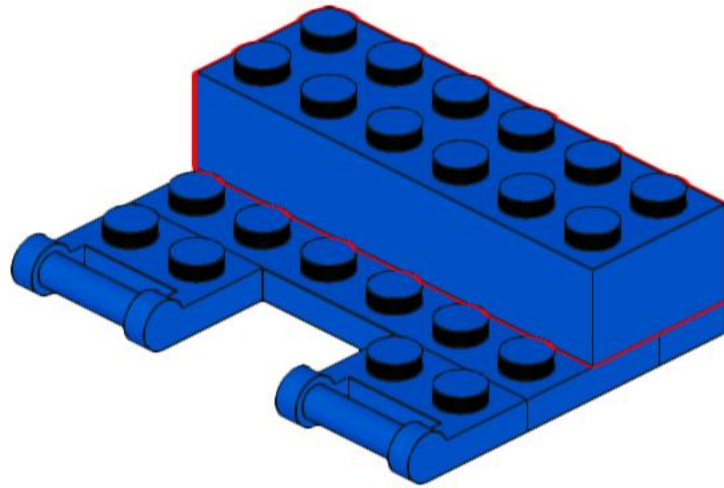

4

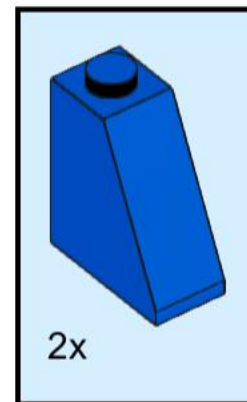
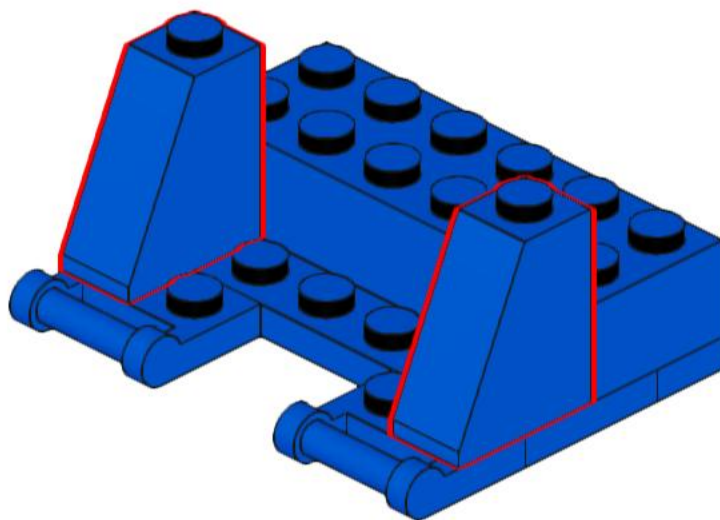

5

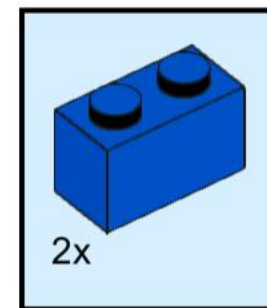
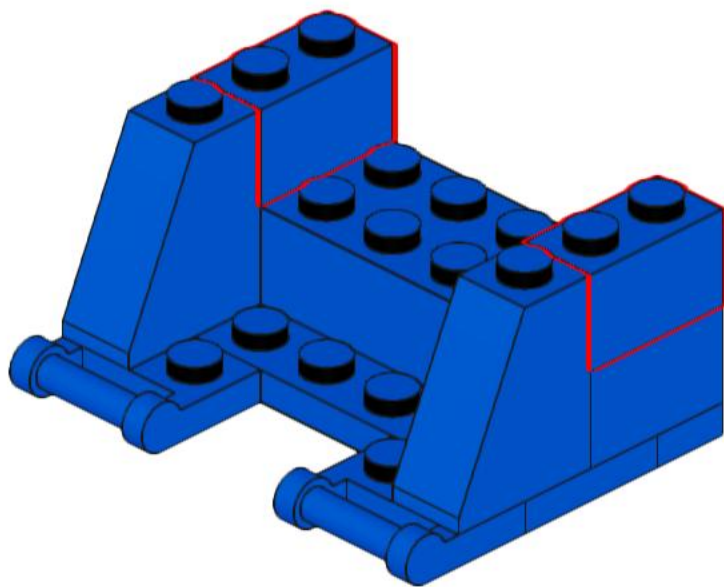

6

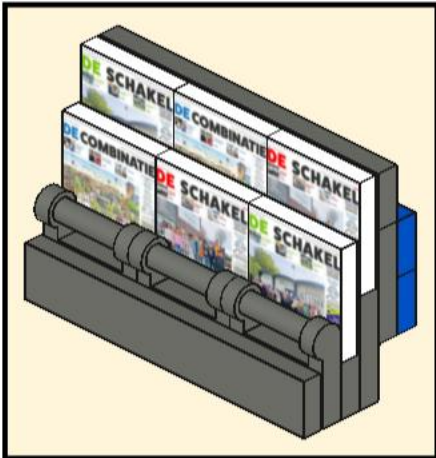
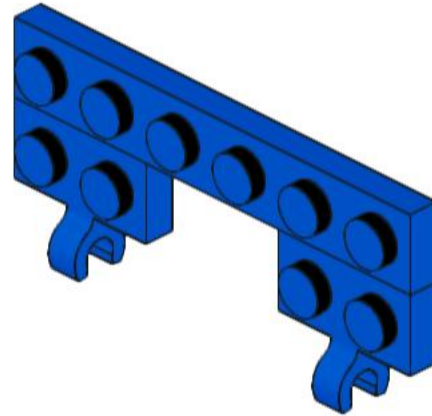
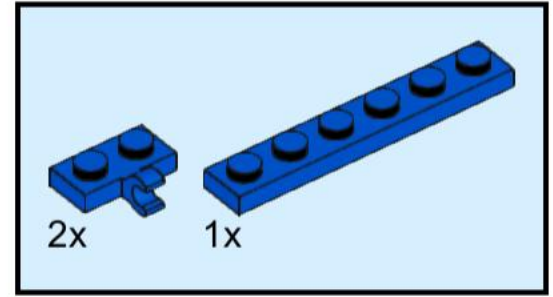

7

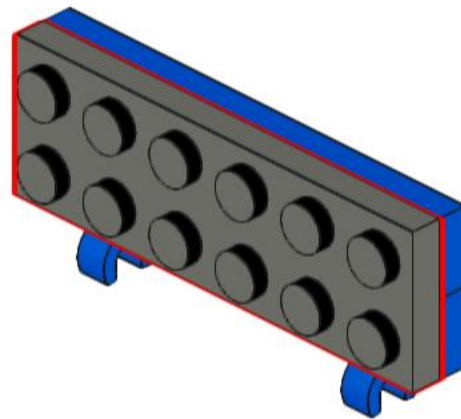
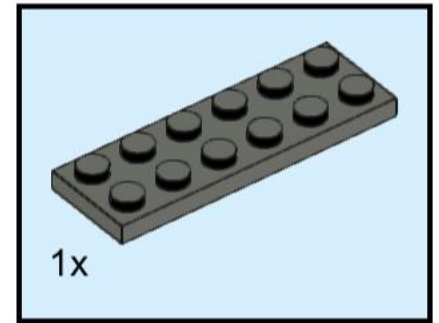

8

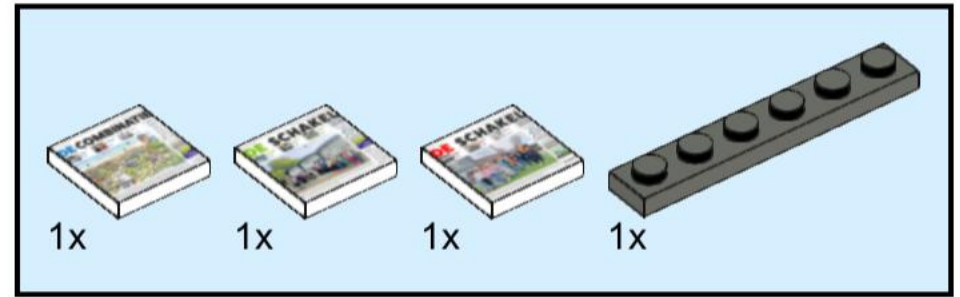

9

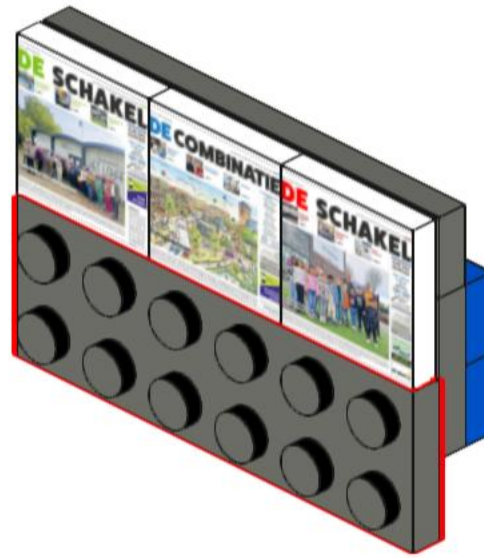
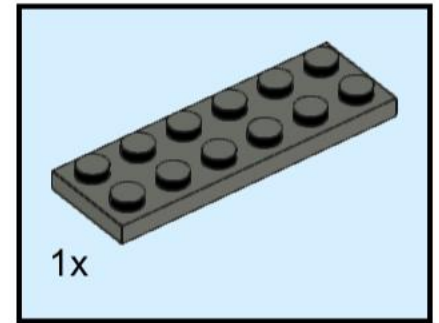

10

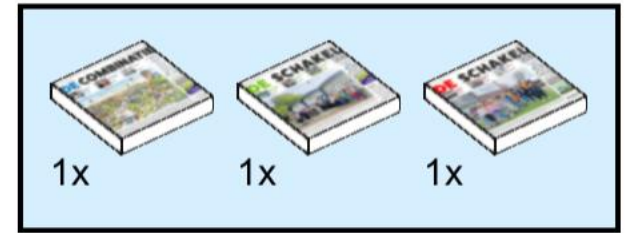

11

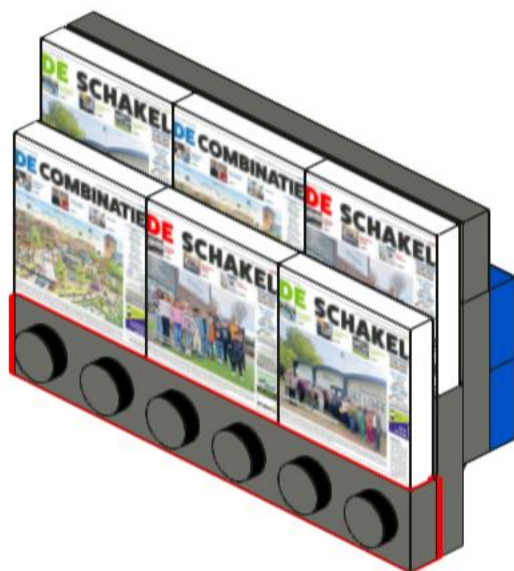
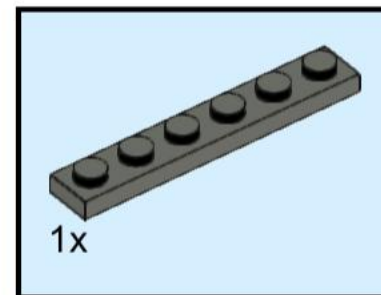

12

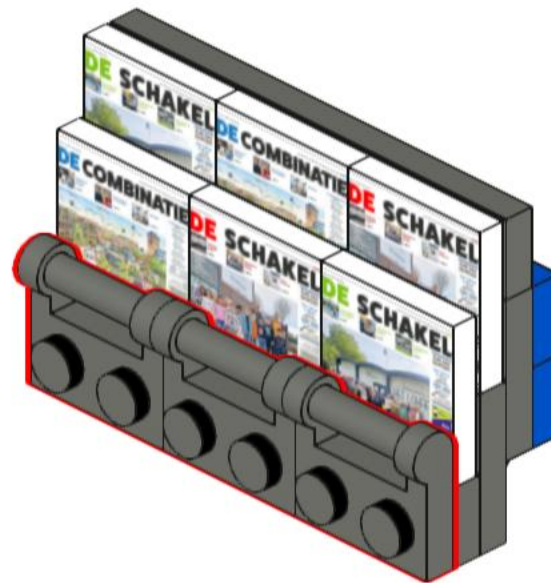
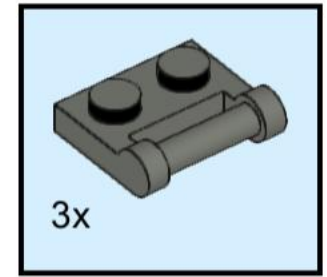

13

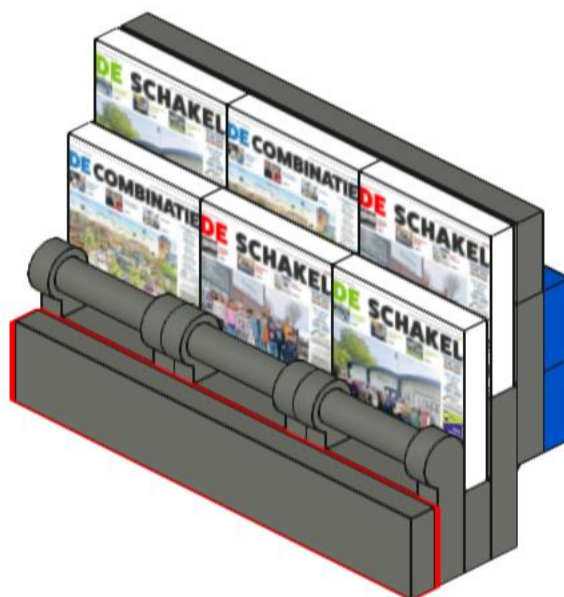
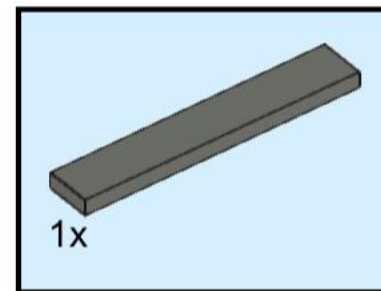

14

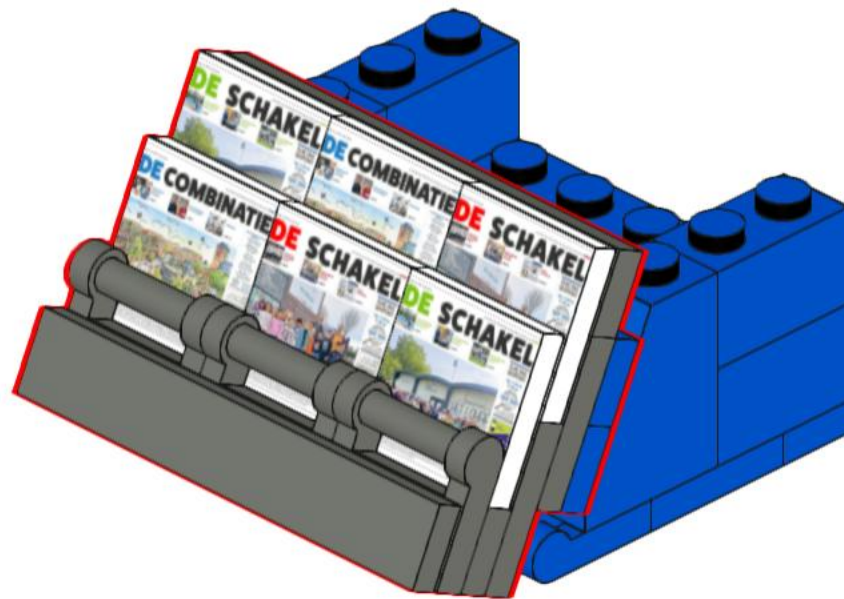

15

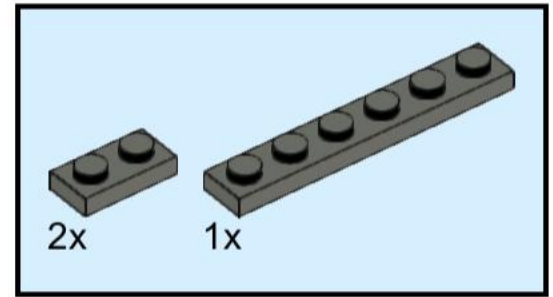

16

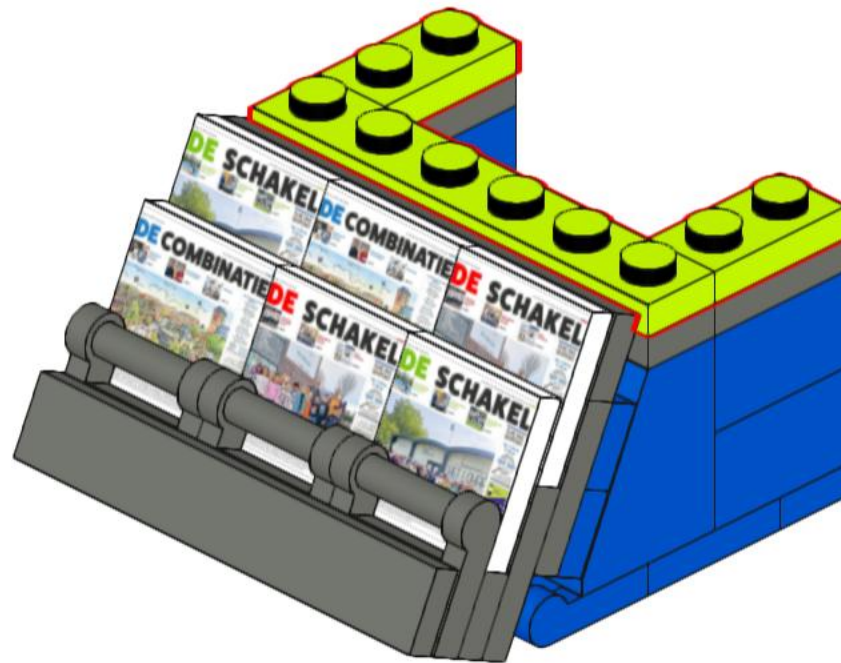
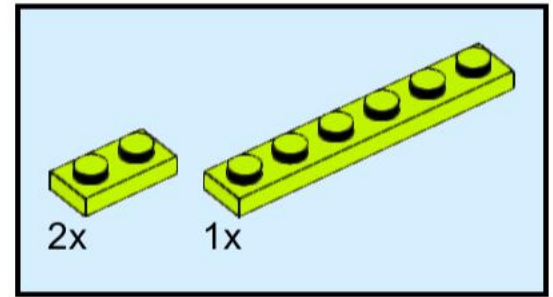

17

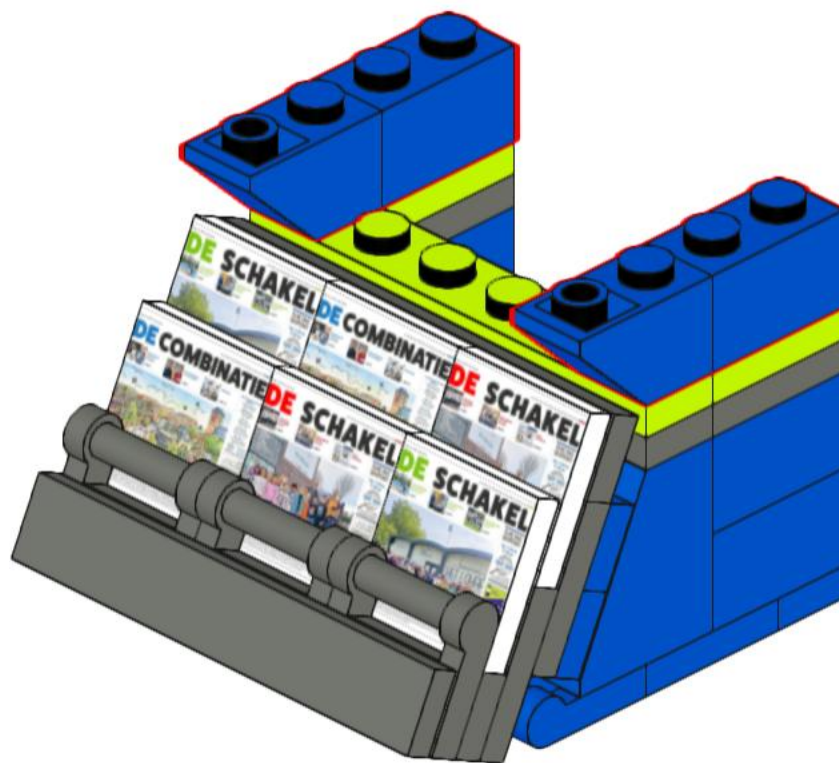
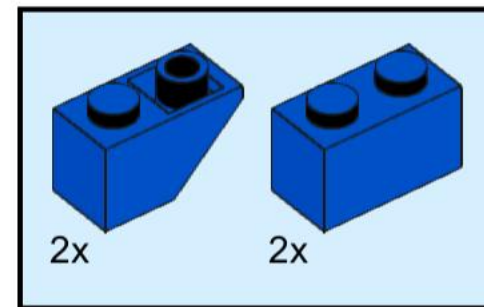

18

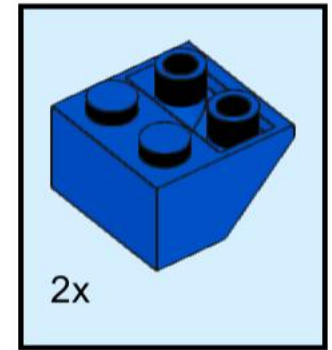
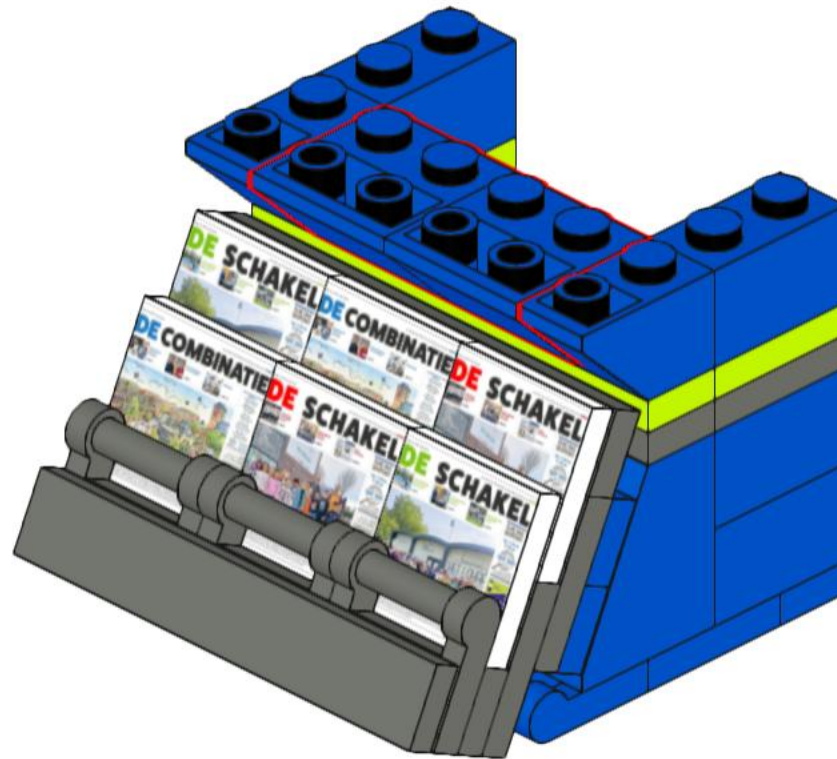

19

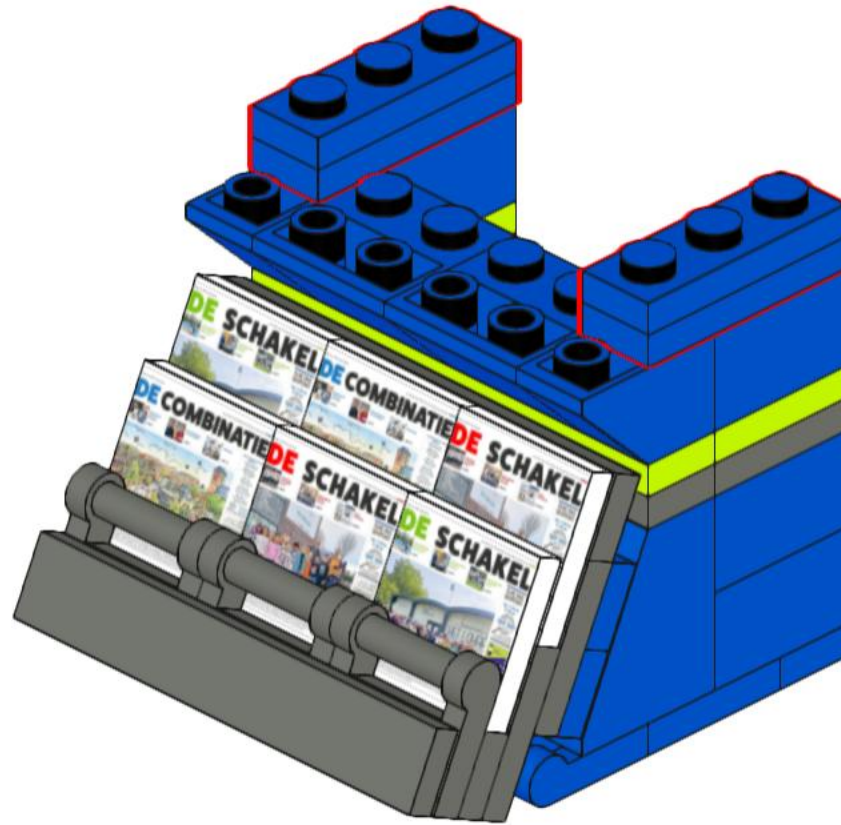
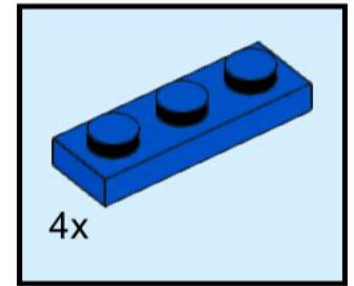

20

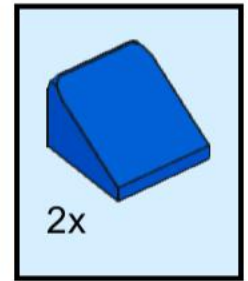
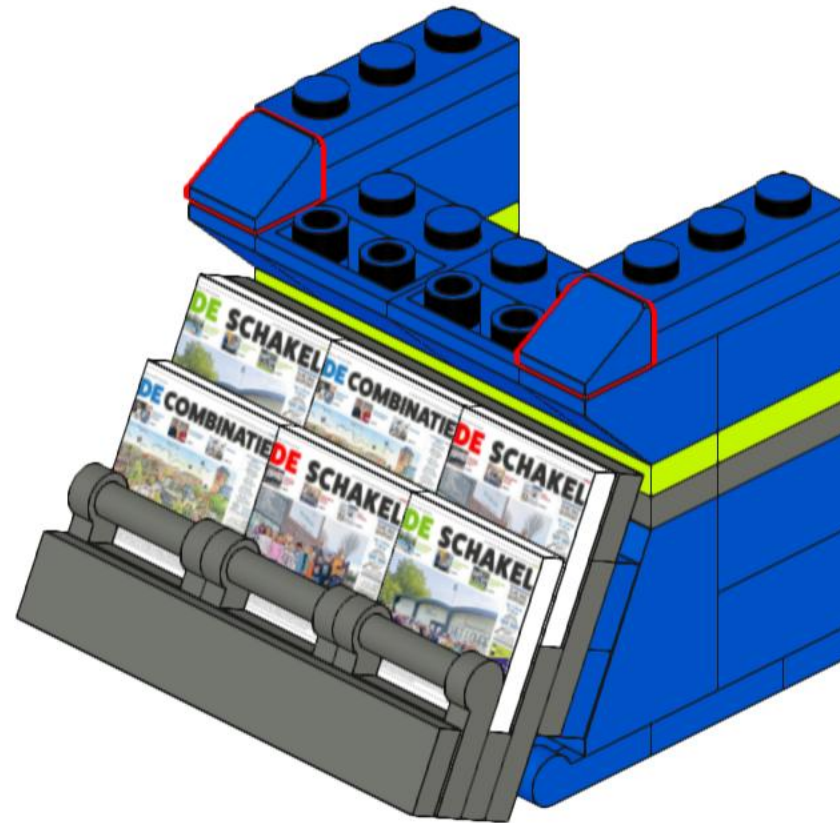

21

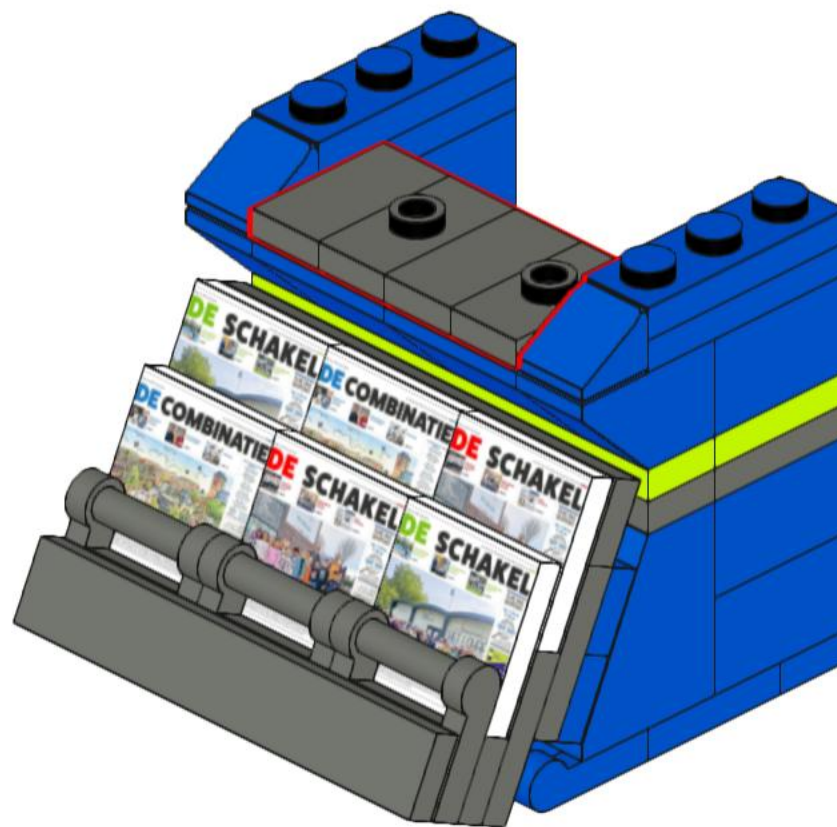
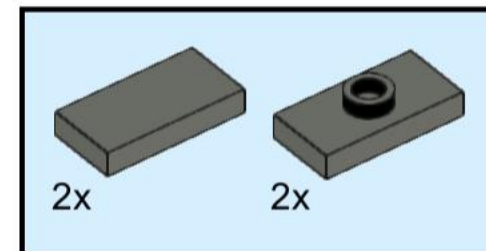

22

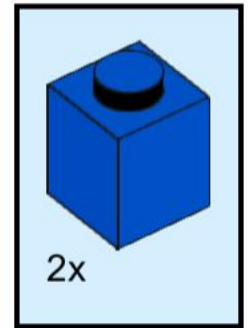
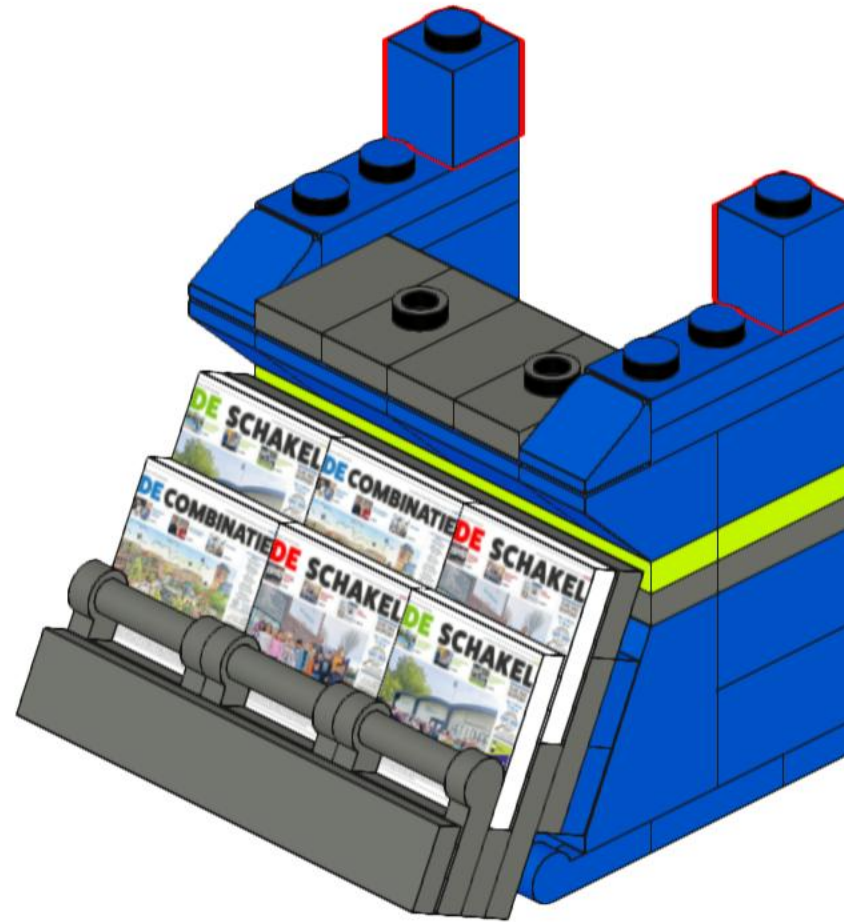

23

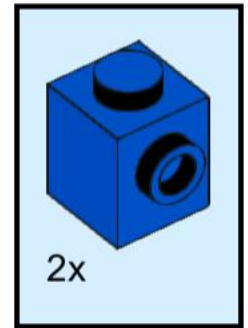
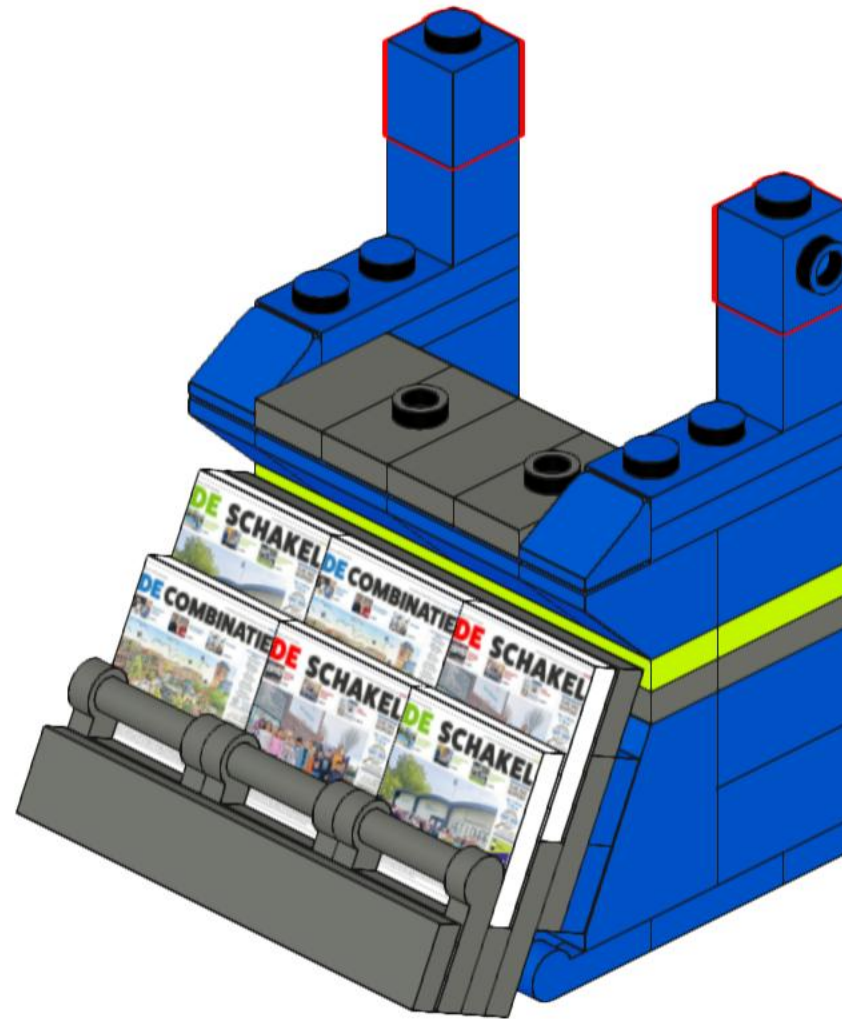

24

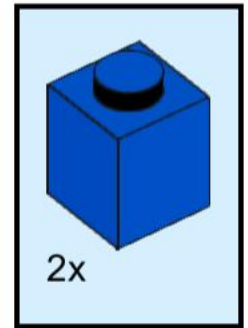
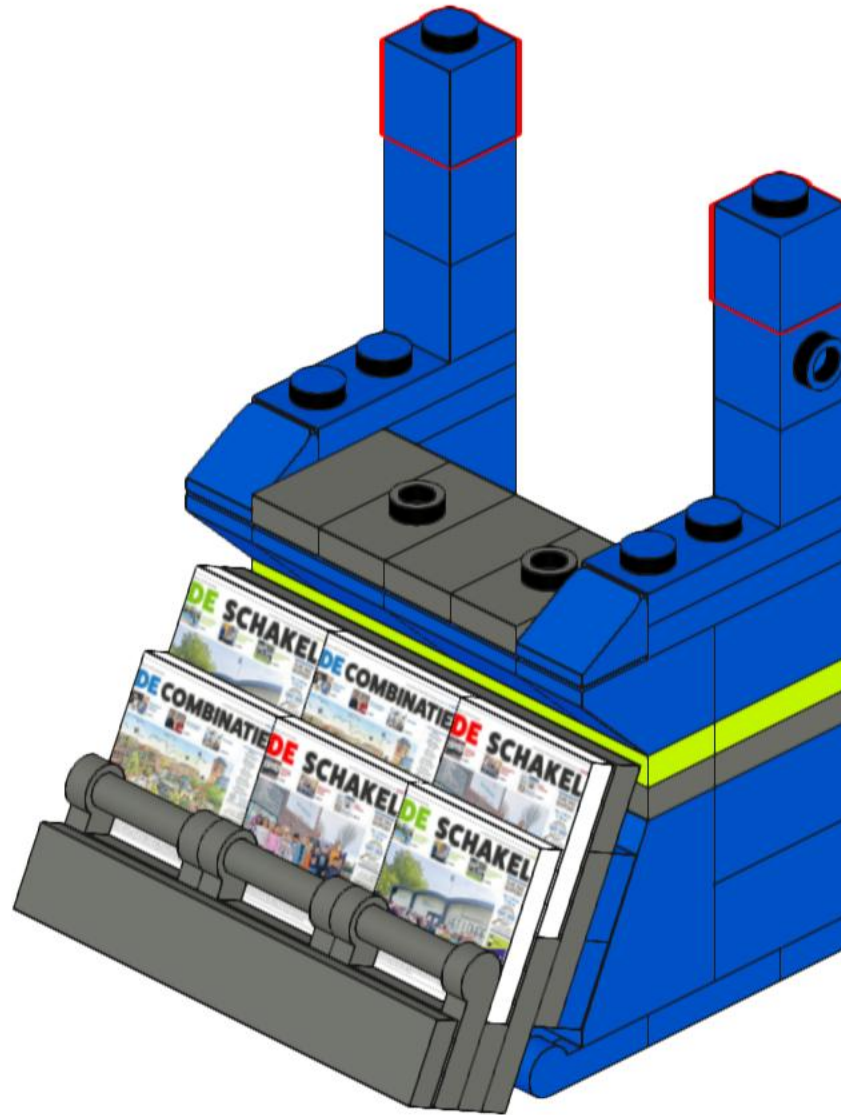

25

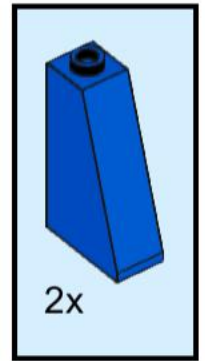
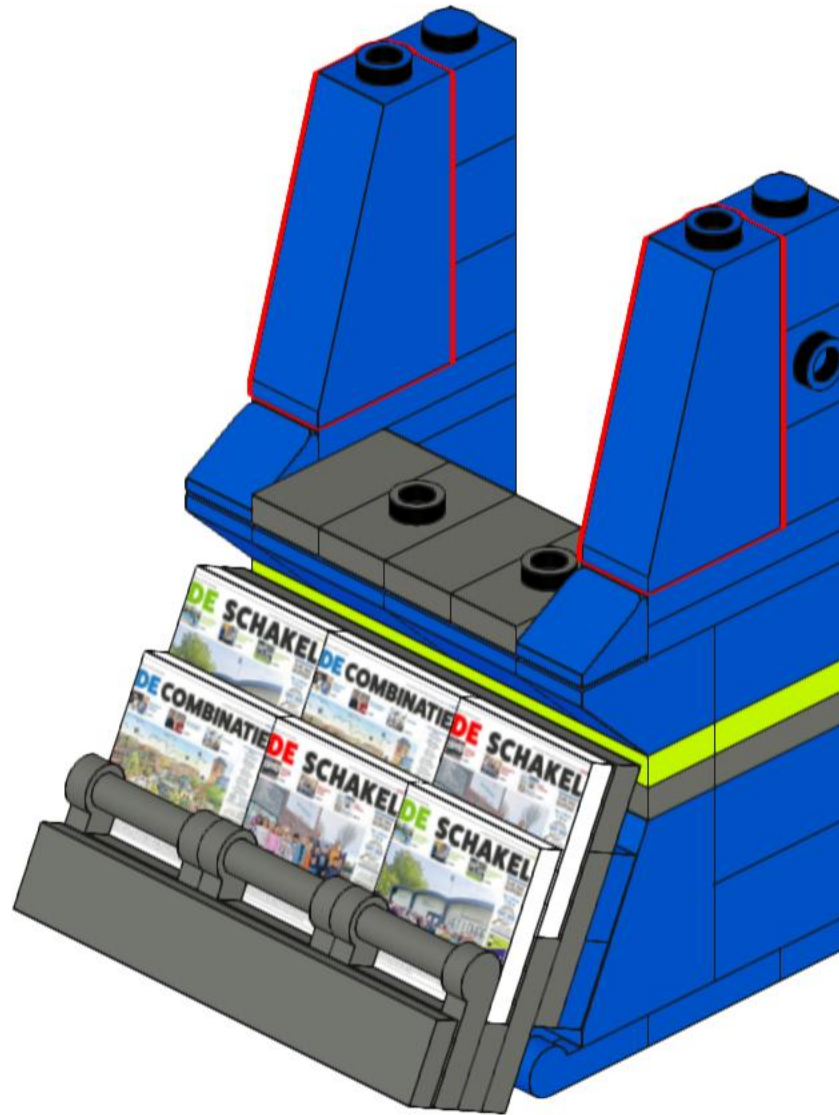

26

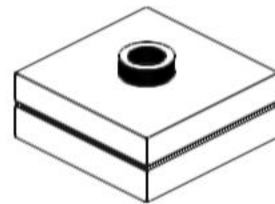
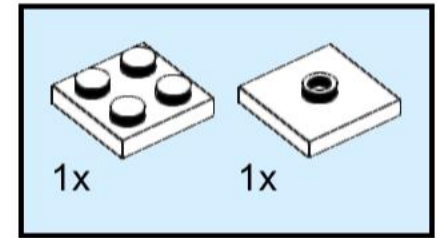

27

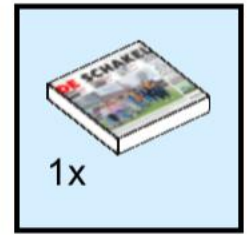

28

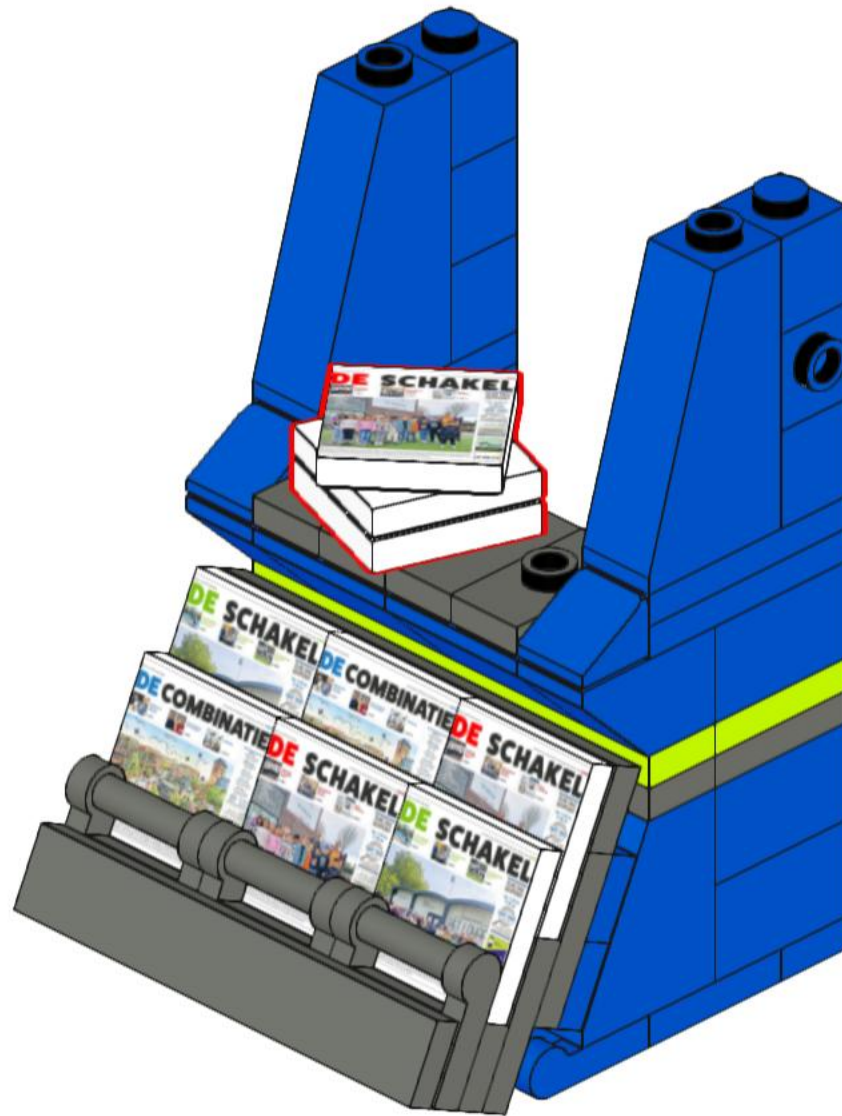

29

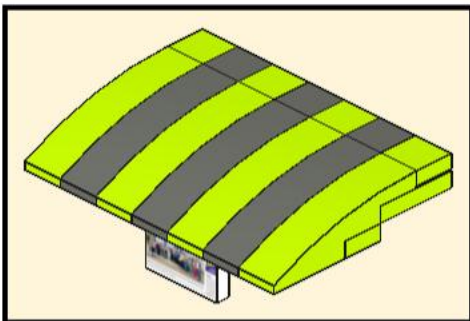
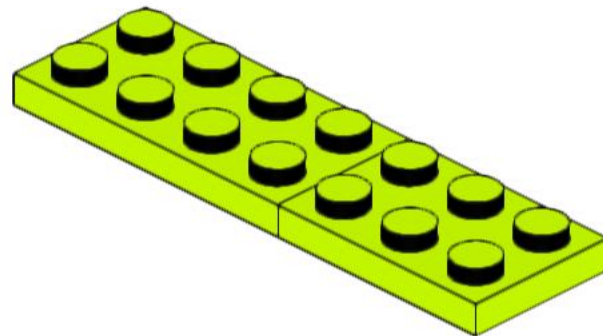
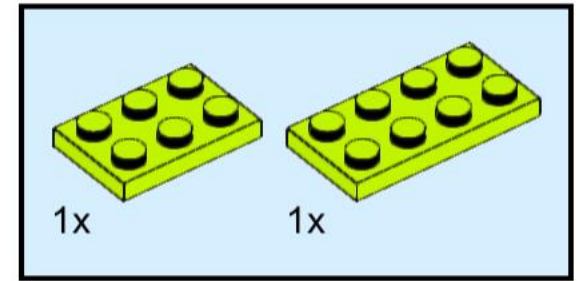

30

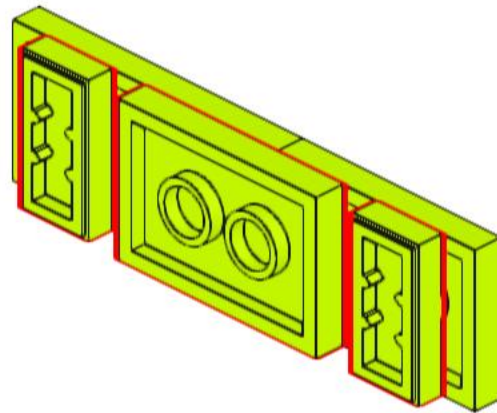
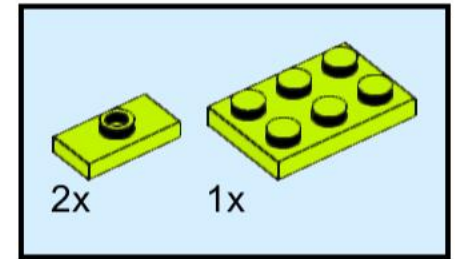

31

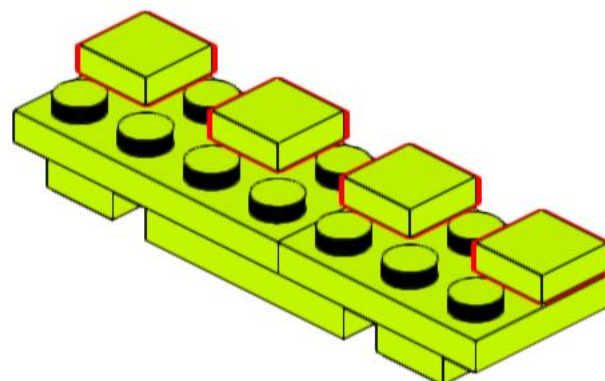
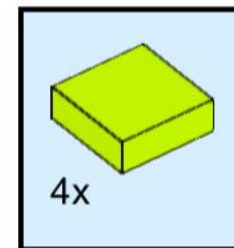

32

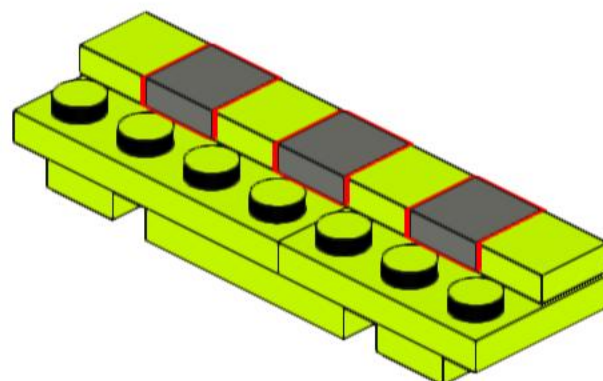
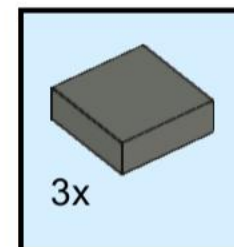

33

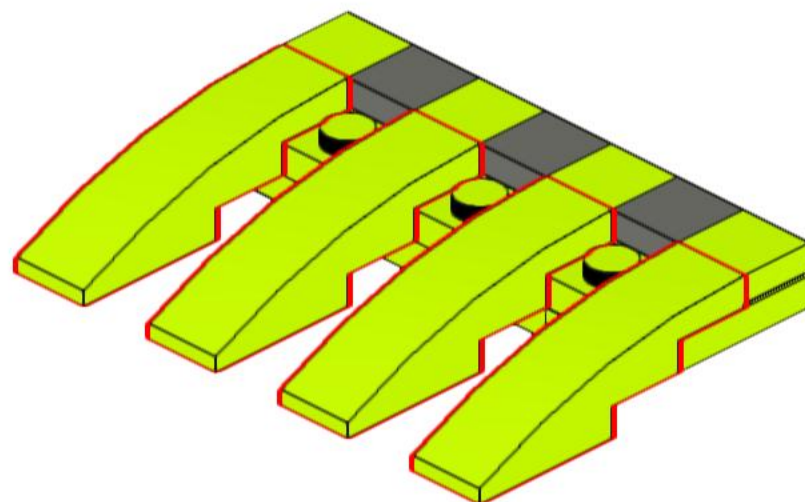
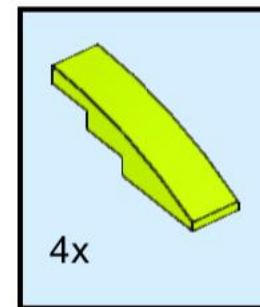

34

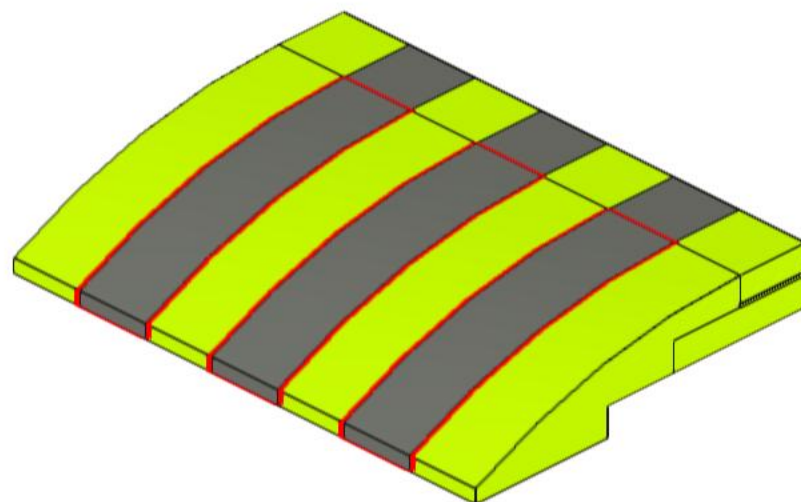
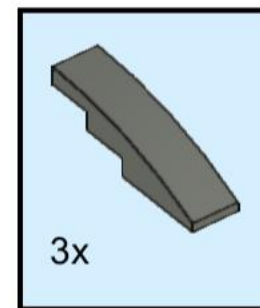

35

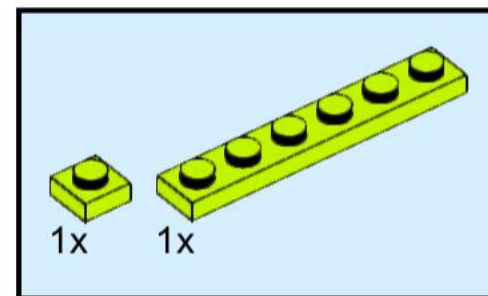
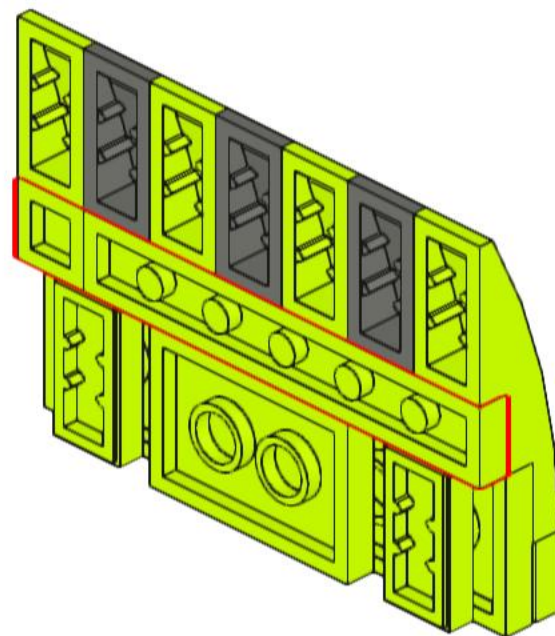

36

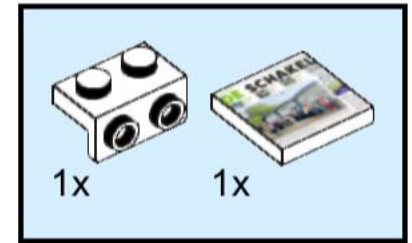

37

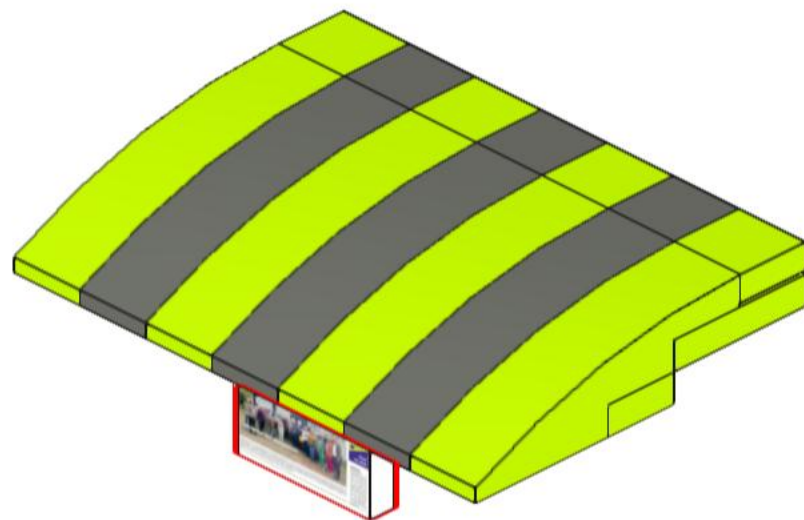

38

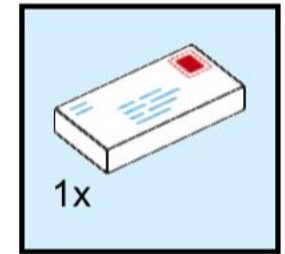
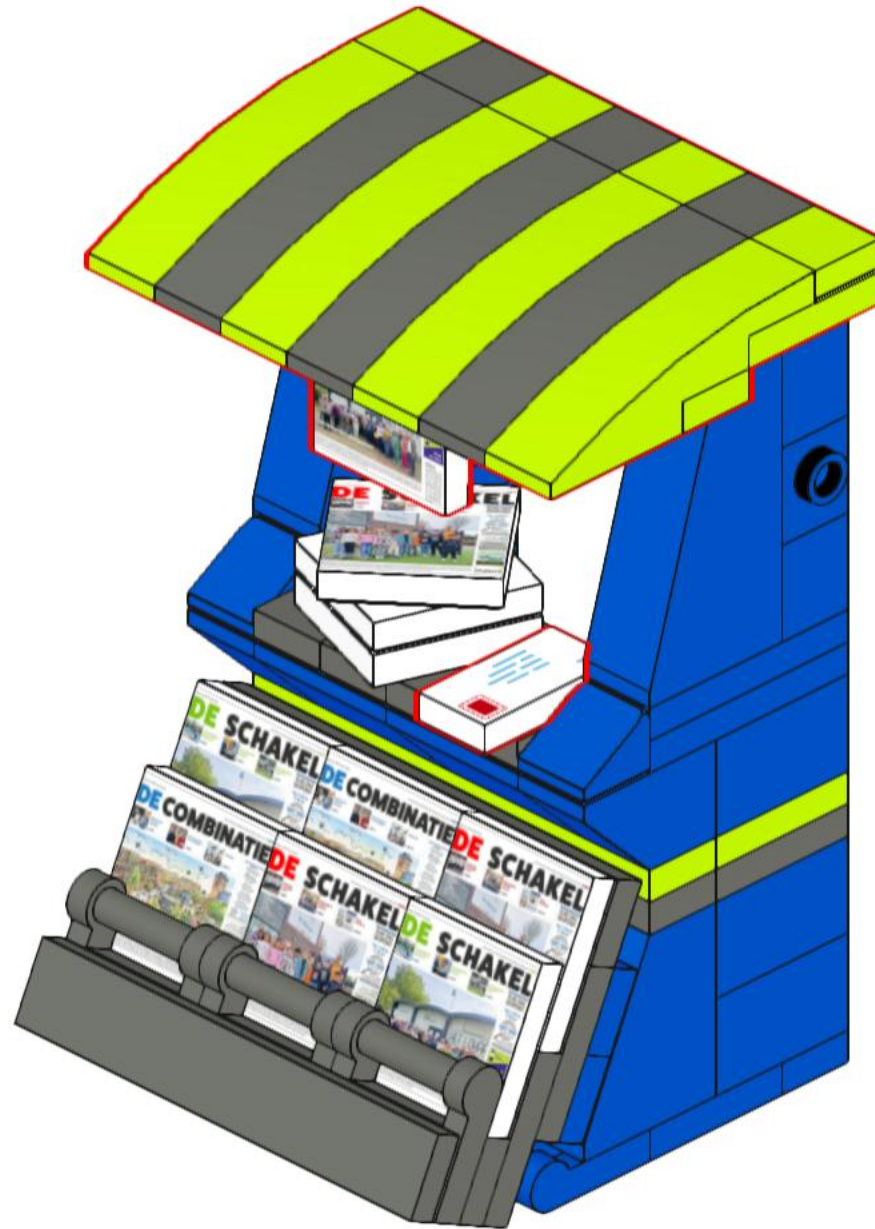

39

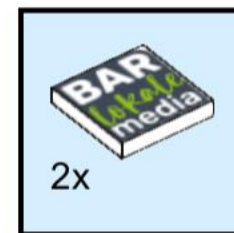
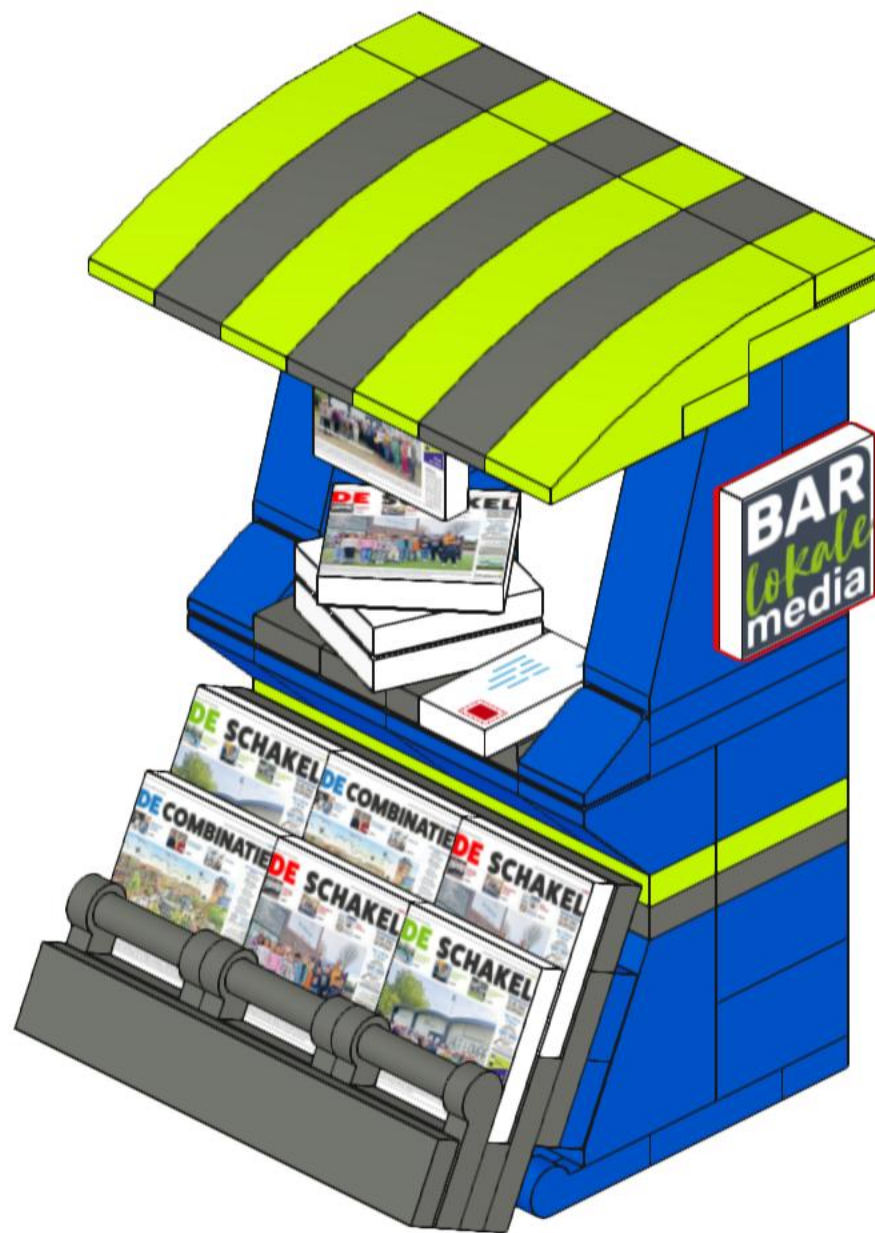

40

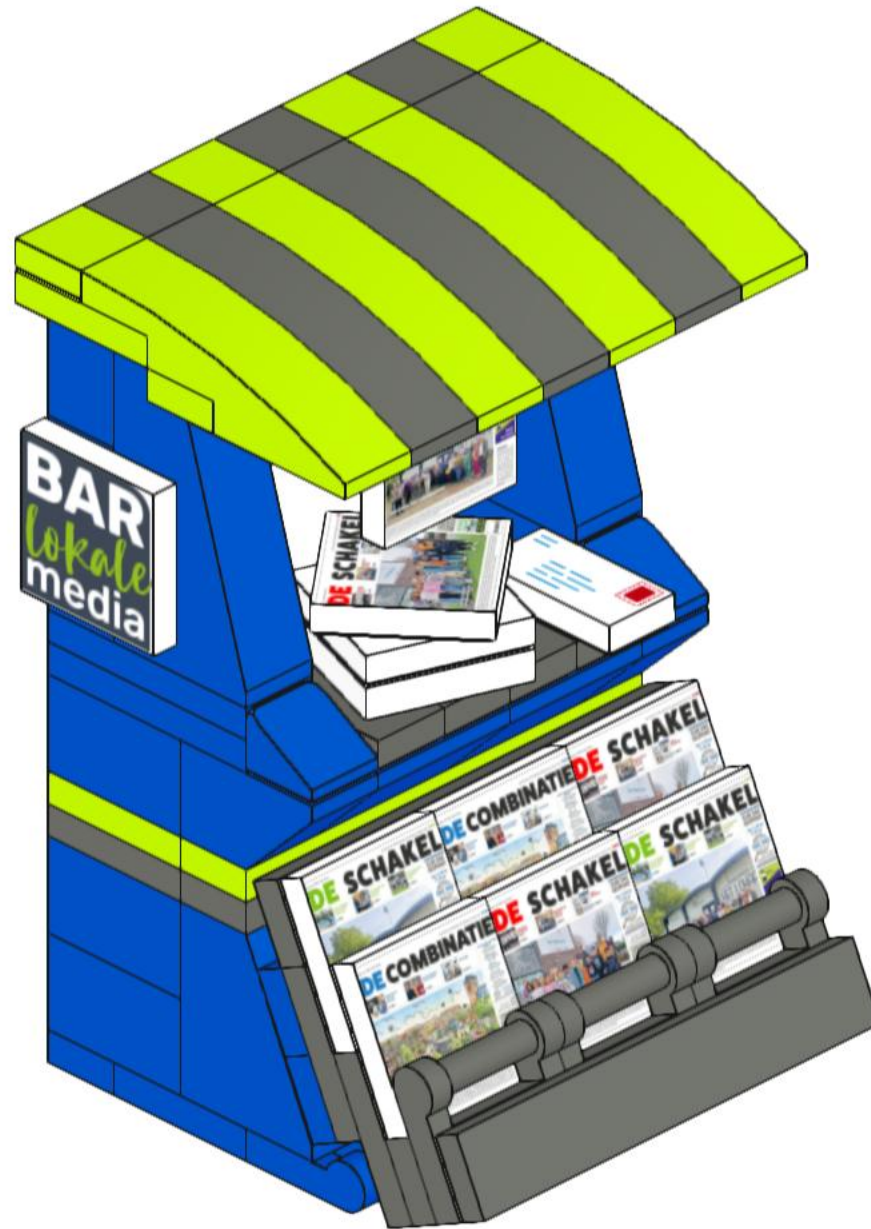

41

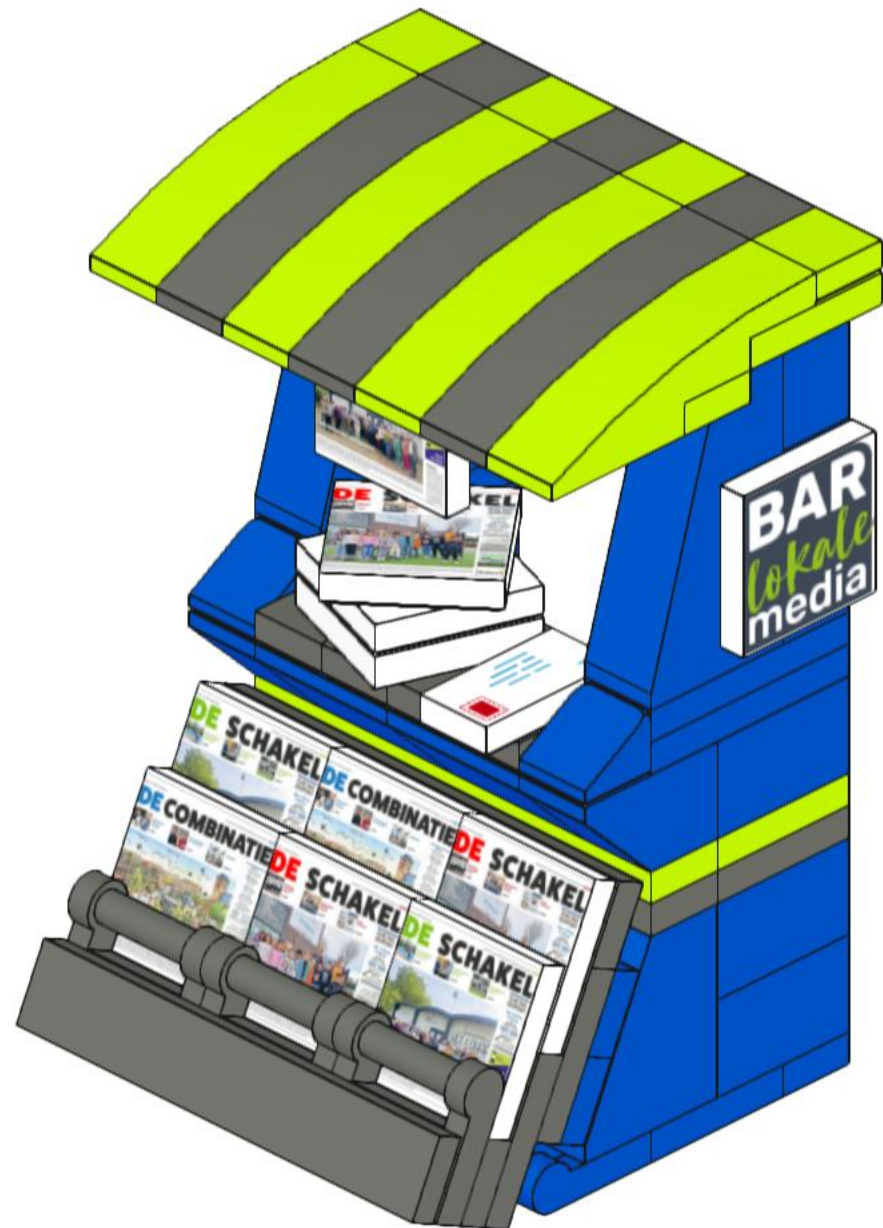

42

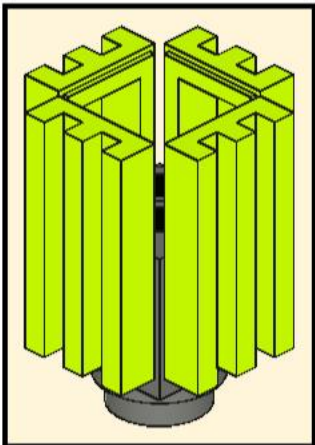
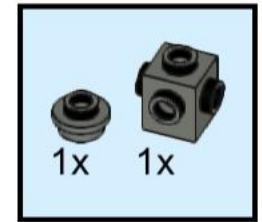

43

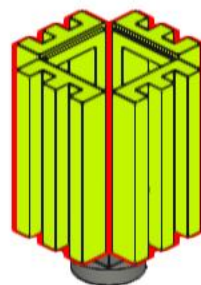
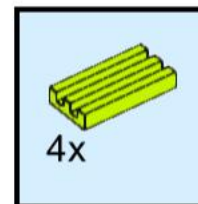

44



45

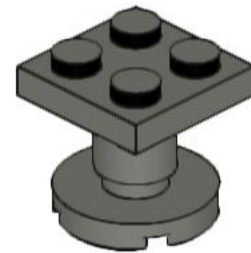
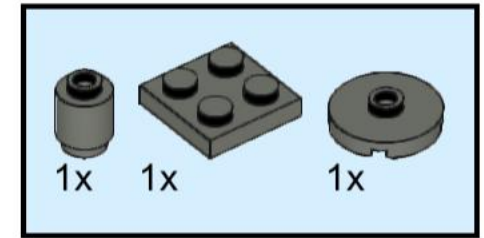

46

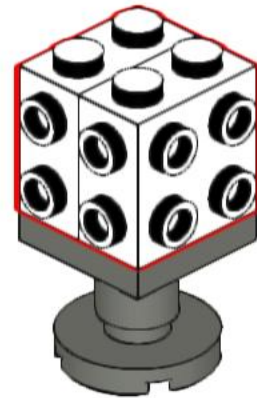
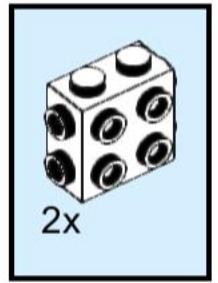

47

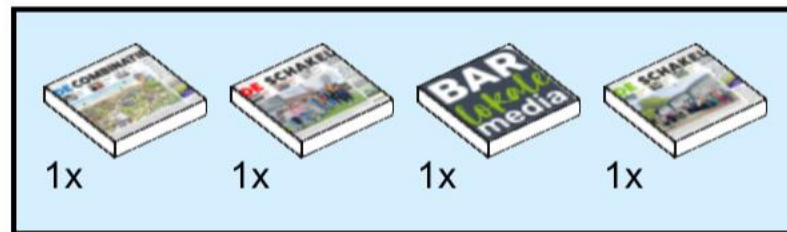

48

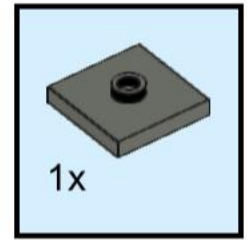

49

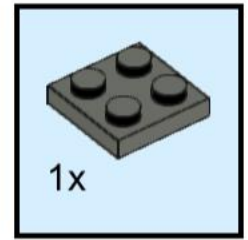

50

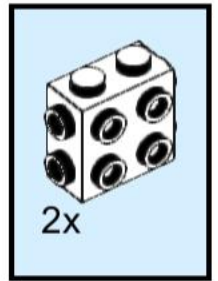

51

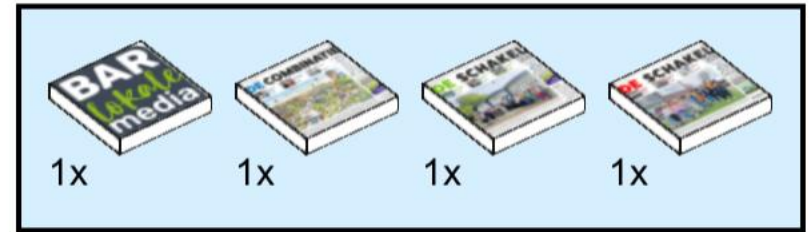

52

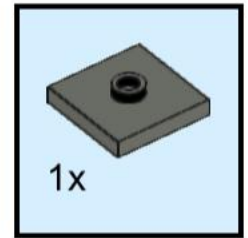

53

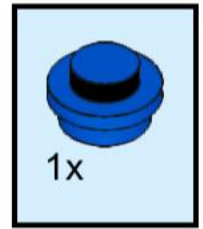

54

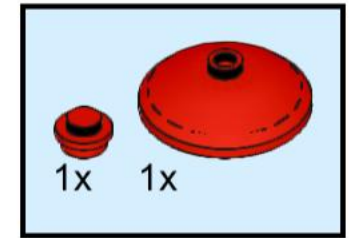

55



56

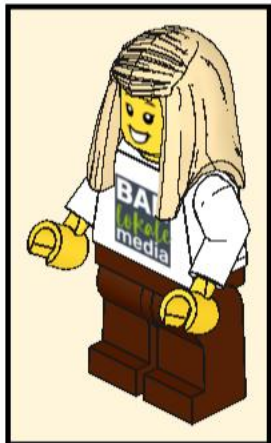
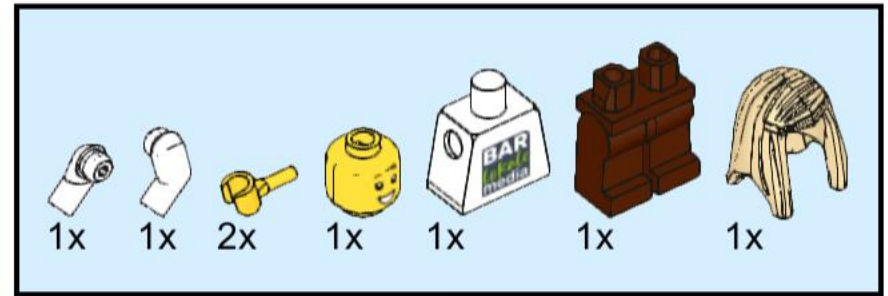

57

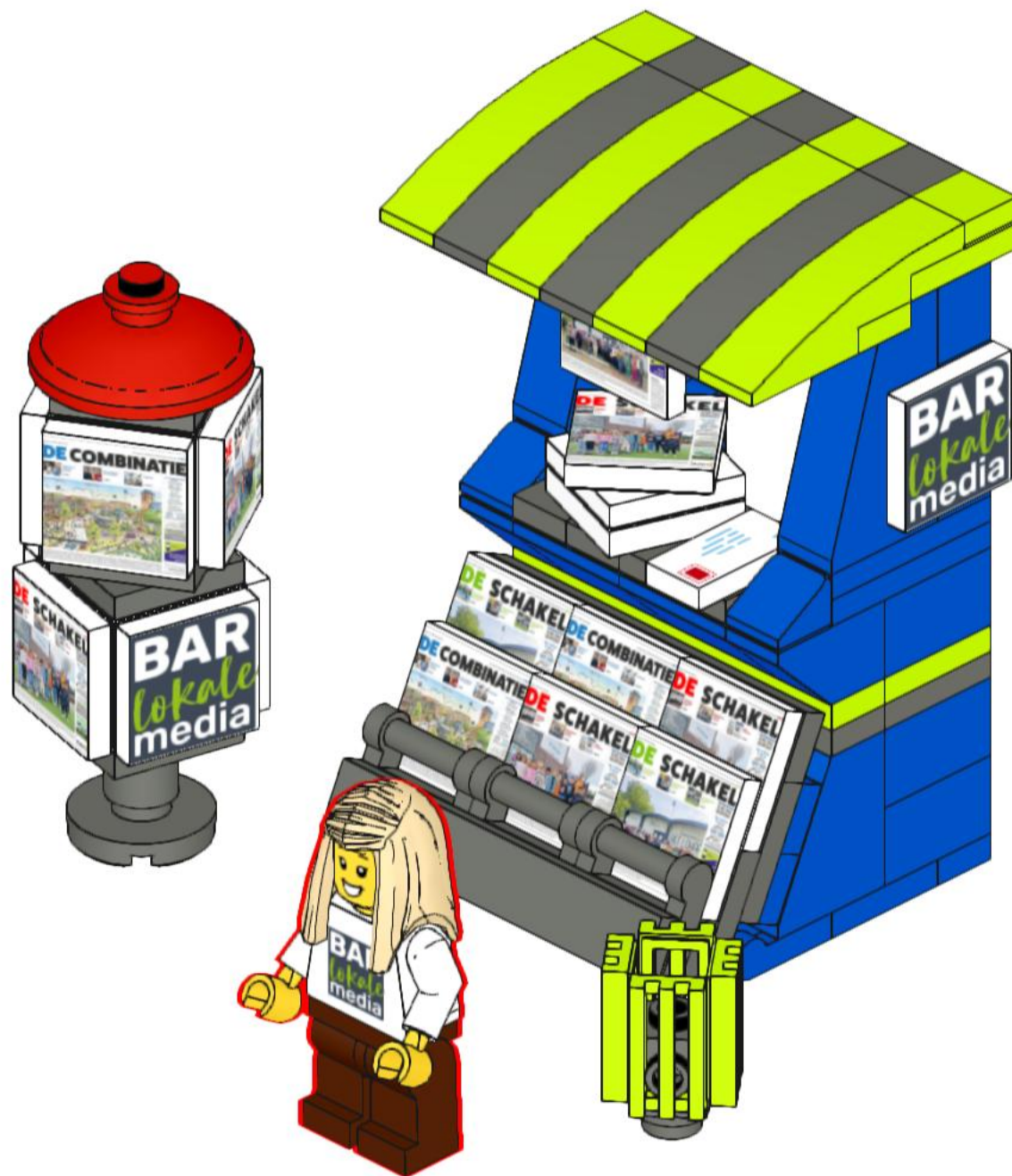

BAR
lokale
media

58

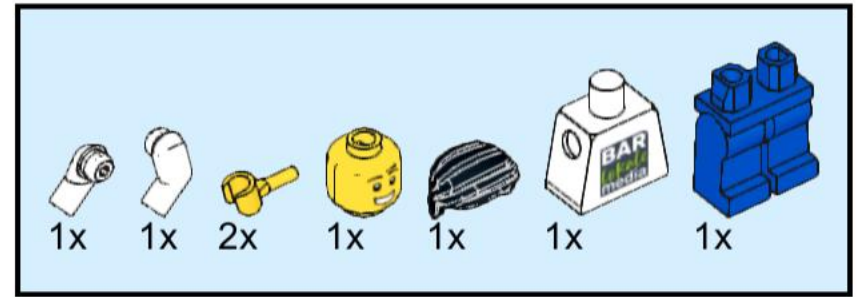

59

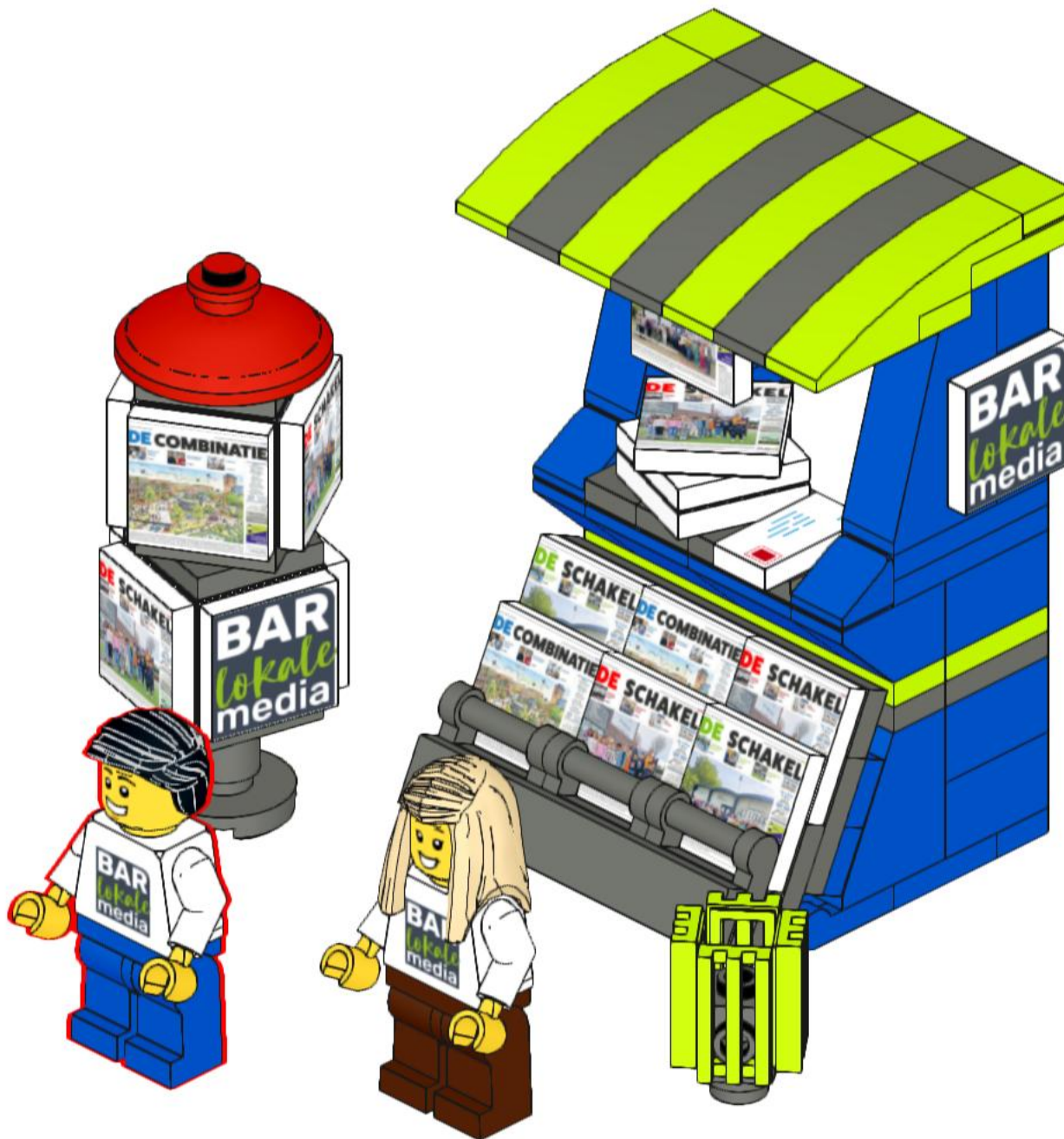



1x

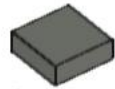

3x



1x



1x



2x



2x



2x



1x



3x



2x



1x

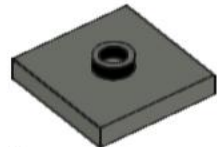

2x

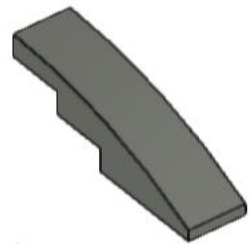

3x

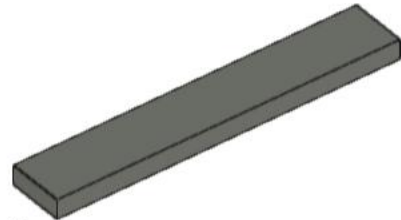

1x

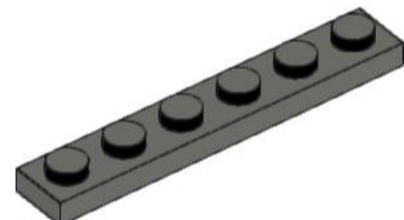

3x

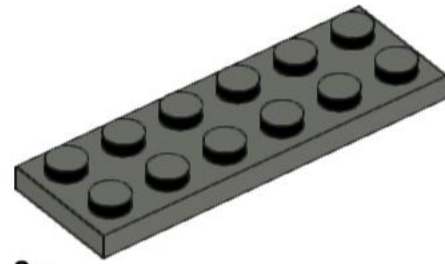

2x



2x



2x

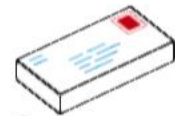

1x

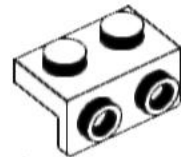

1x



5x

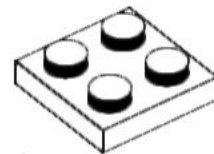

1x

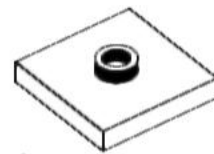

1x



5x



4x



4x



2x

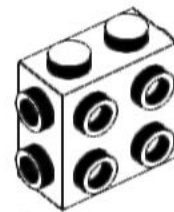

4x



1x



1x



1x



1x

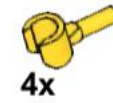

4x



1x



1x

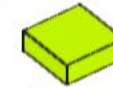

4x

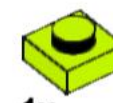

1x

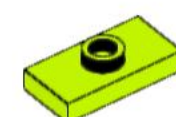

2x



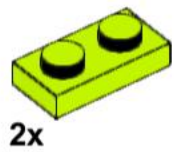

2x

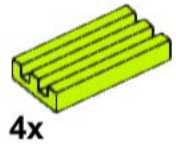

4x

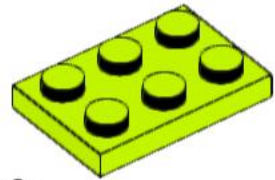

2x

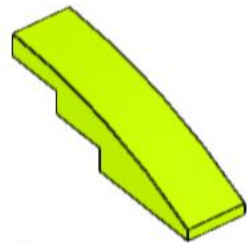

4x

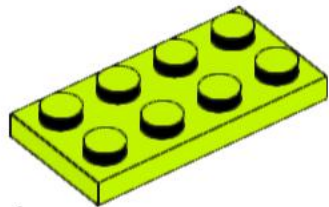

1x

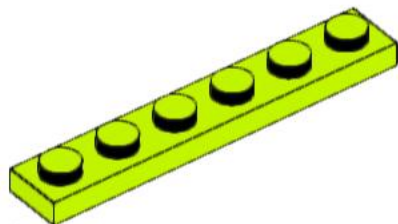

2x



1x



2x



4x



2x

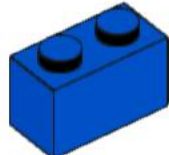

4x

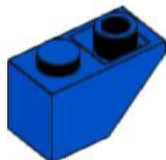

2x



2x

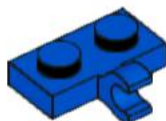

2x

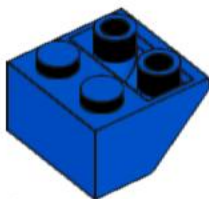

2x

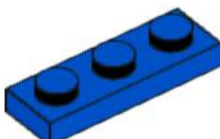

4x

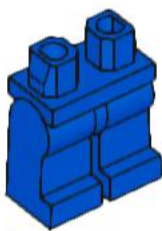

1x

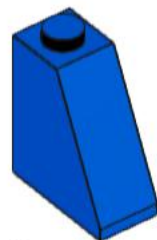

2x

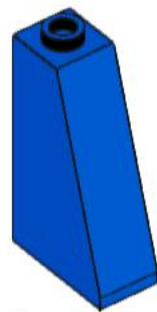

2x

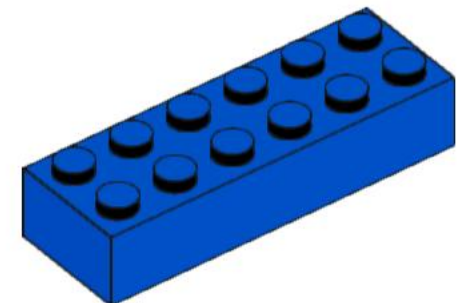

1x

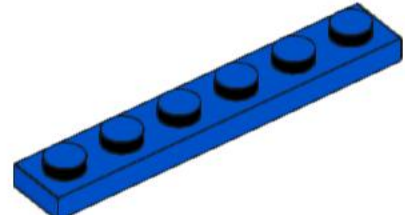

2x

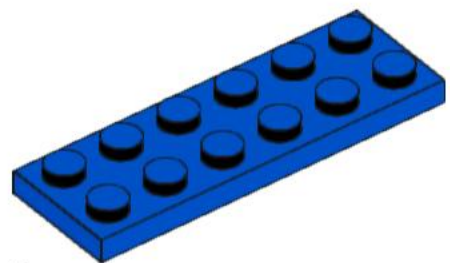

1x